

SIDE UNIT ONIX +

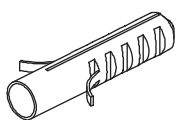

BO-719 / A **x4**

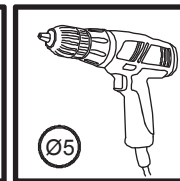
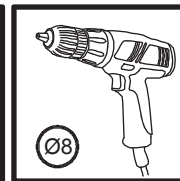
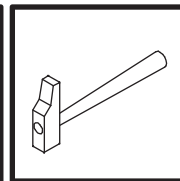
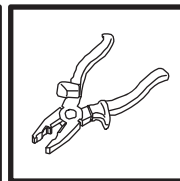
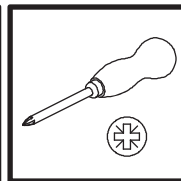
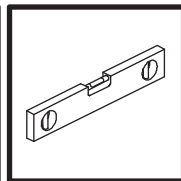
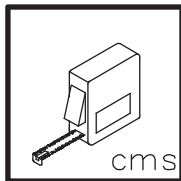
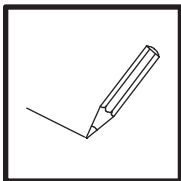
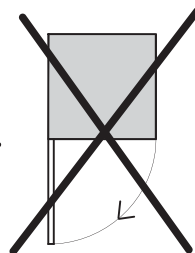
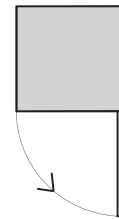
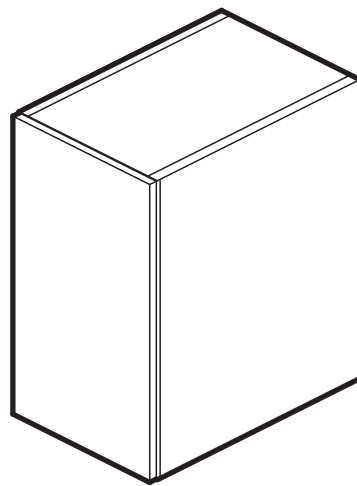
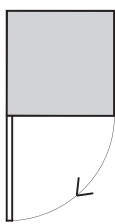
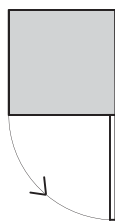
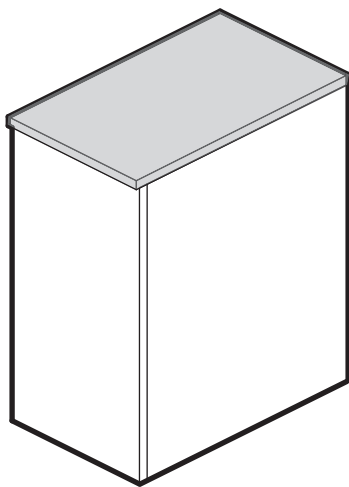
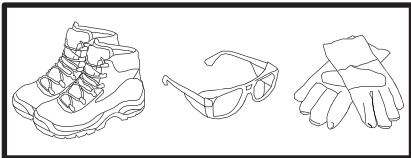
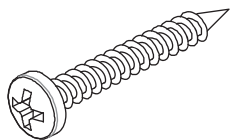

BO-719 / B **x4**

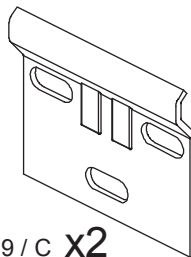

BO-719 / C **x2**



- 132061 **x4**
- 138650 **x4**
- 132062 **x4**
- 138445 **x4**

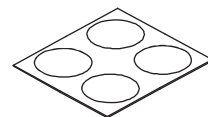

- 112460 **x6**
- 139896 **x6**
- 139799 **x6**
- 142760 **x6**

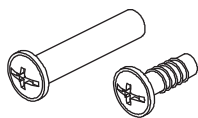

128059 **x2**



BO-814 **x4**

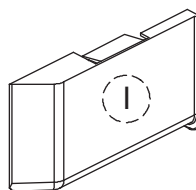

138163 **x1**

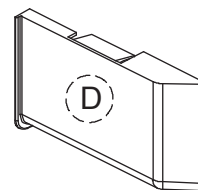

138161 **x1**

01.

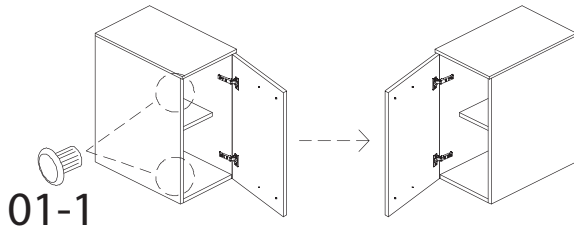
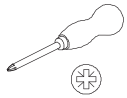

- 132061 x4
- 138650 x4
- 132062 x4
- 138445 x4

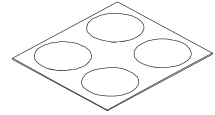

- 112460 x6
- 139896 x6
- 139799 x6
- 142760 x6

01-2

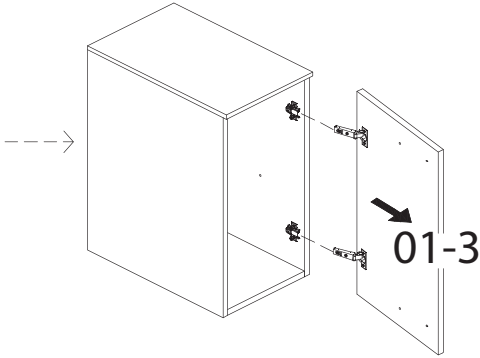
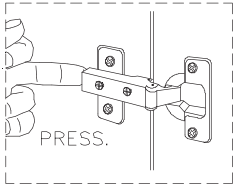

01-4

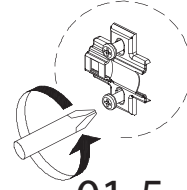

01-6

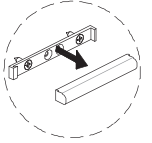

01-5

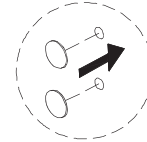

01-7

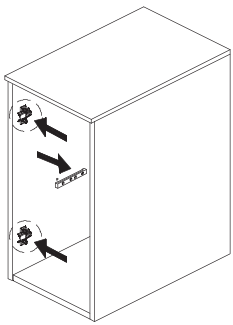
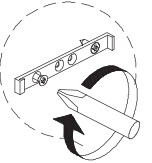

01-8

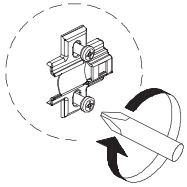

01-9

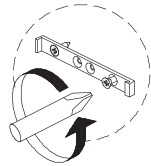

01-10

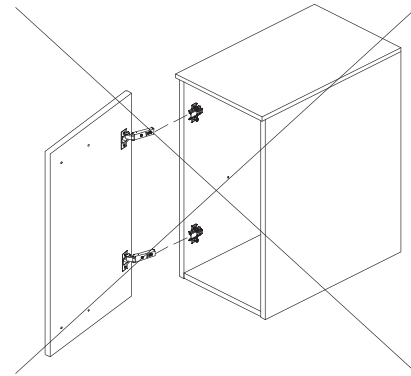
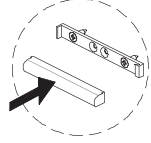

02.

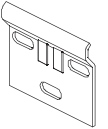
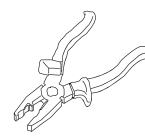
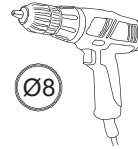
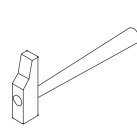
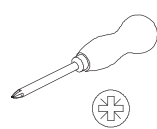
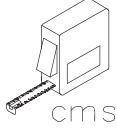
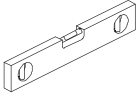
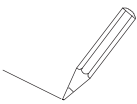

BO-719 x2



BO-719/B x4

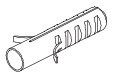

BO-719/A x4

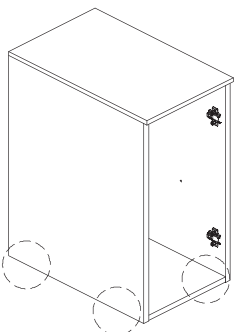

02-1

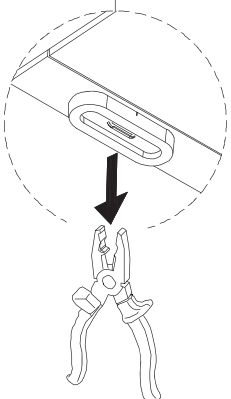

02-2

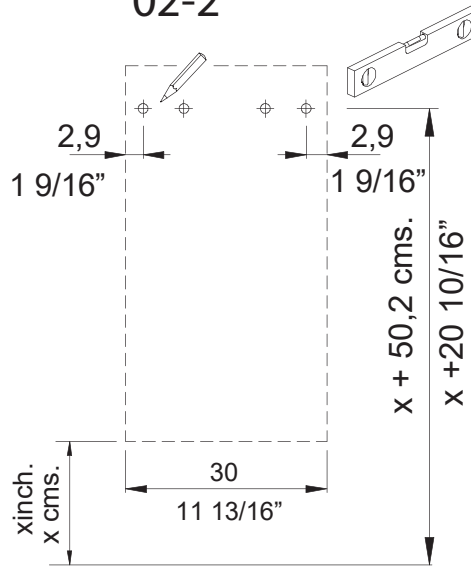

02-3

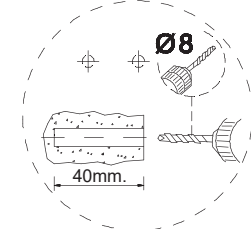

02-4

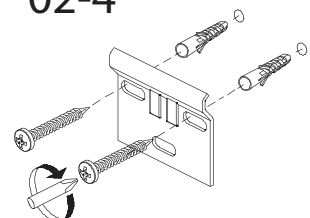

03.

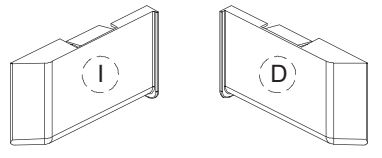
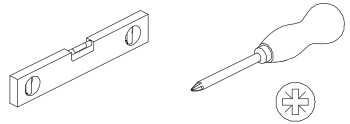

138163 X1

138161 X1

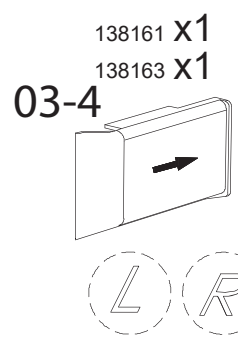
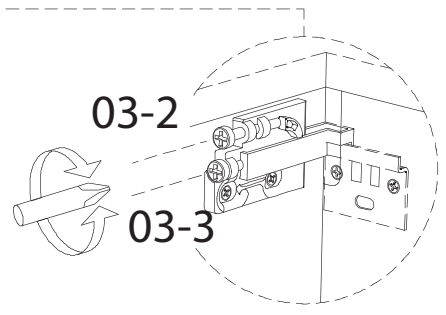
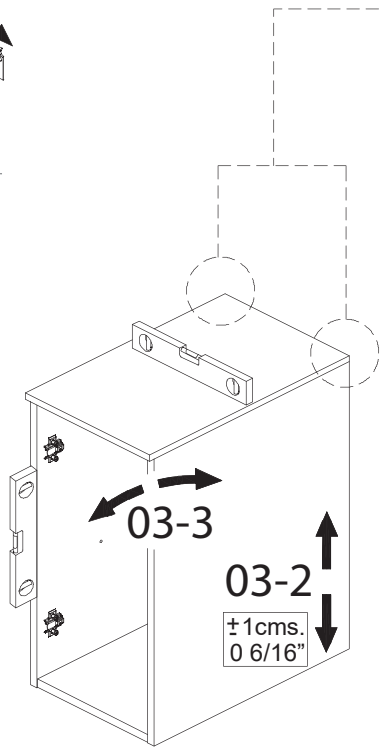
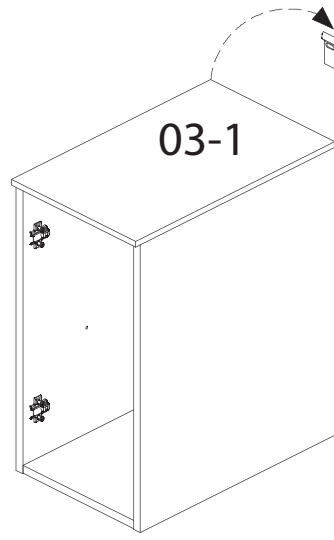

04.

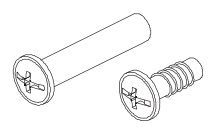
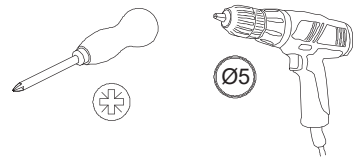

128059 X2

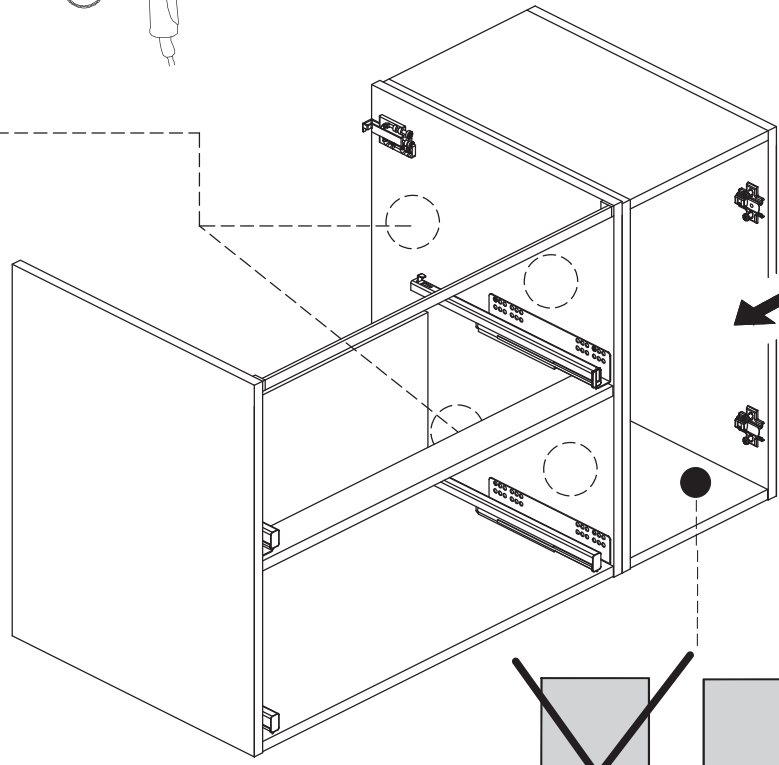
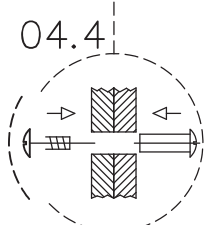
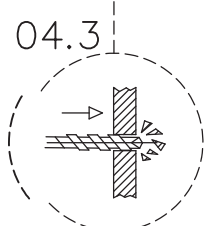
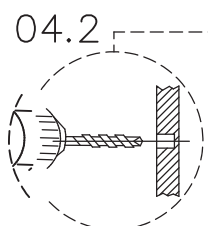

04.1

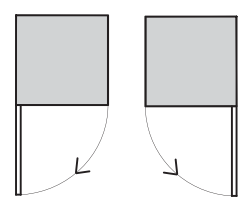
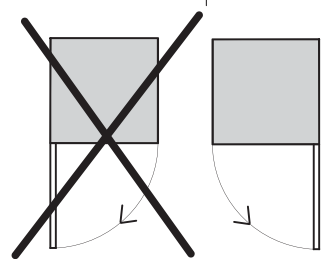
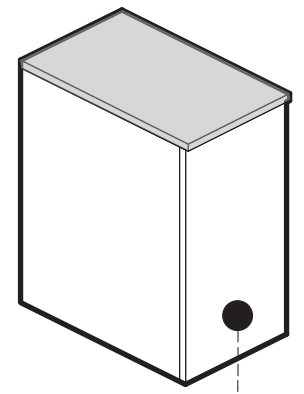

05.

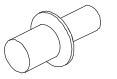
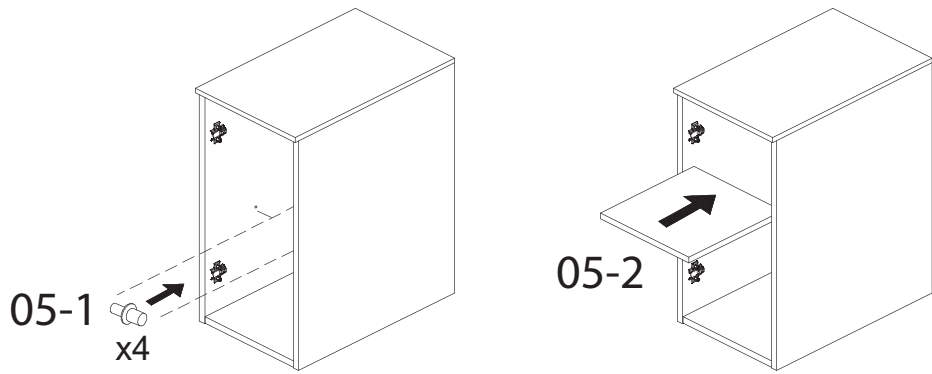

BO-814 X4

06.

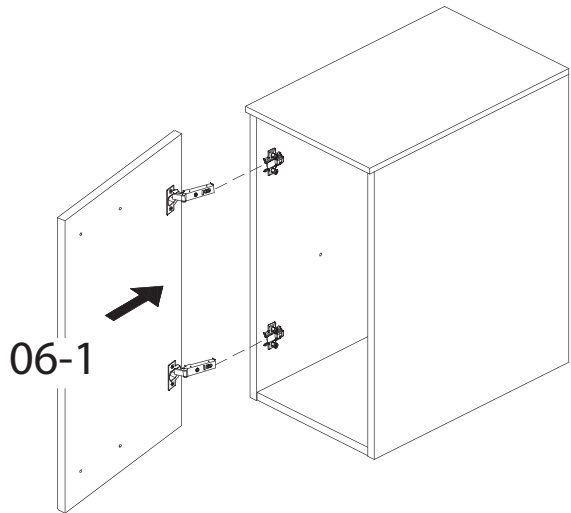
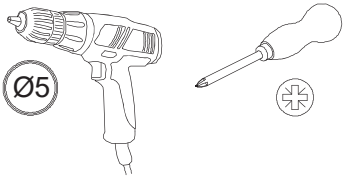

06-2

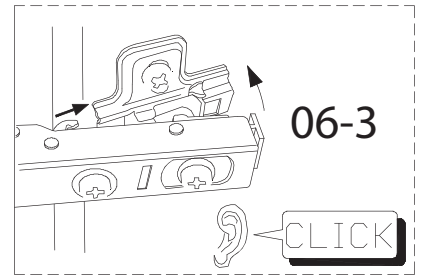

07.

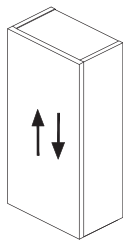
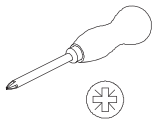

07-1

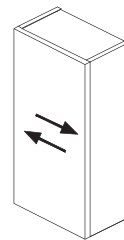
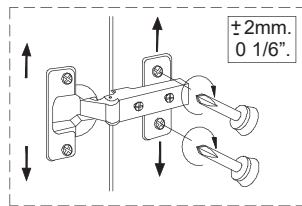

07-2

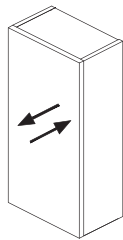
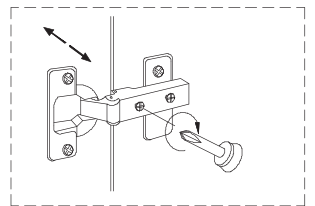

07-3

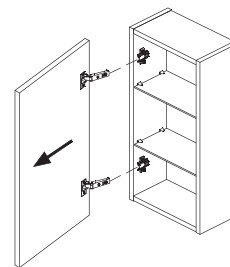
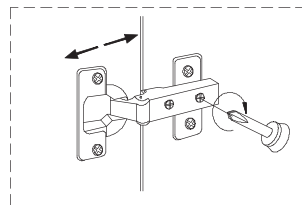

07-4

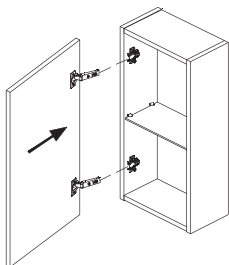
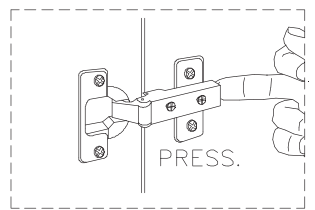

07-5

